



## Typical Applications

- Military Tactical Radios
- Military Radar
- Test and Measurement Equipment
- Industrial and Medical Equipment

## Features

- 1 Watt CW power handling
- 5.5 dB typ. IL and 6.5 typ. Shape factor
- 10 W CW survival time (2 min.)
- Fast Tune Time(15 $\mu$ s , typ.)

## Functional Diagram

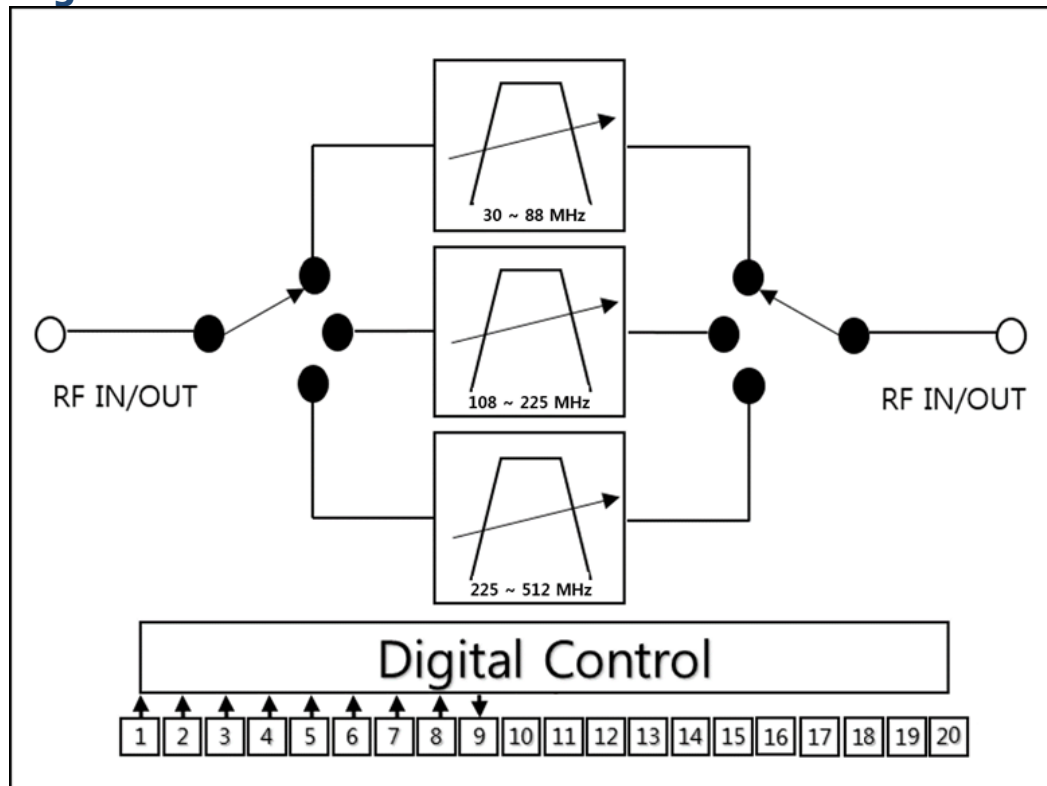

## Discription

- ADTFp 30/520-XX-S is a low-cost, miniature, high performance tunable band pass filter. The ADTFp uses PIN diodes to deliver high filter performance and parallel interface is available to tune the frequency. All ADTFp tunable filters are fully tuned and tested by ADMOTECH for convenience and ease of use.

## 1.0 Pinout and Functional Information

### 1.1 Pin out

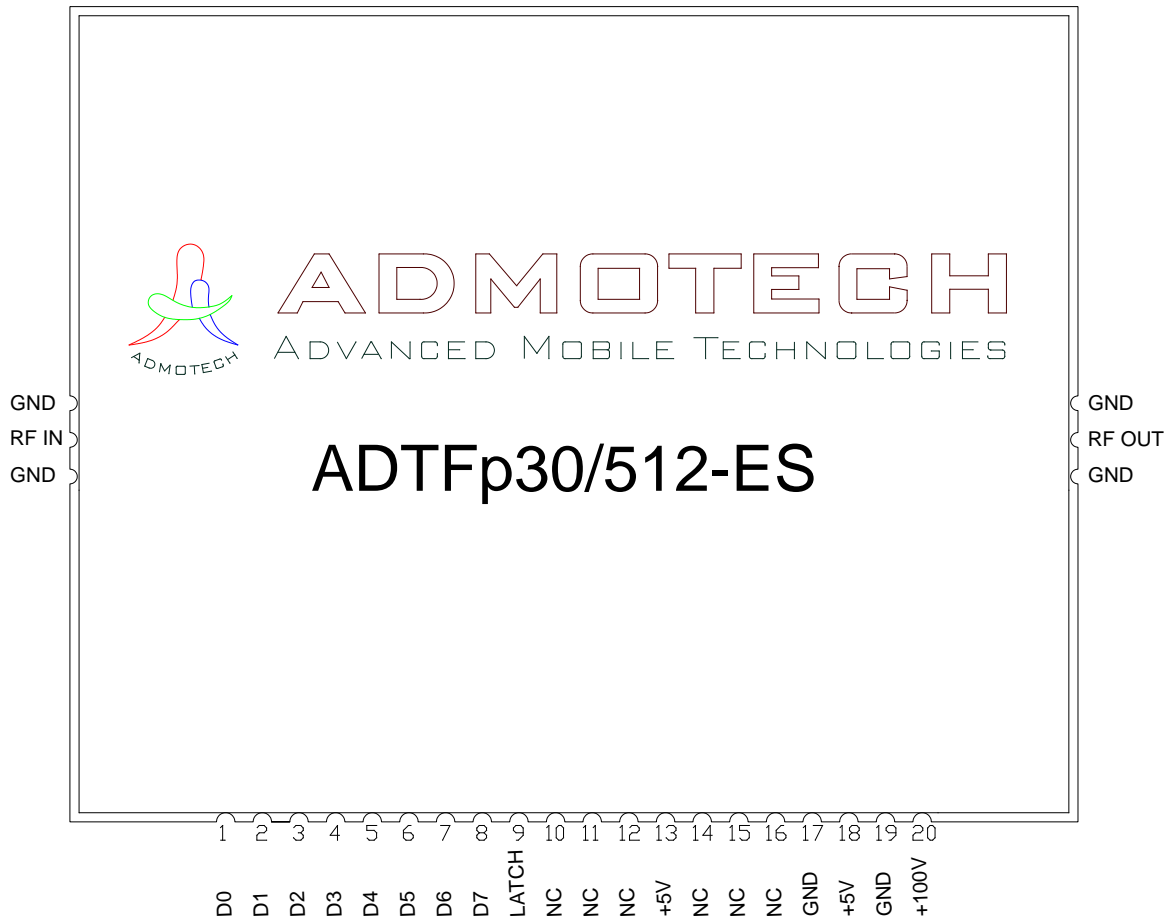

## 1.2 Pin Description

Pin Number	Label	Description
1	D0	Parallel Data Bit0, Tune Command
2	D1	Parallel Data Bit1, Tune Command
3	D2	Parallel Data Bit2, Tune Command
4	D3	Parallel Data Bit3, Tune Command
5	D4	Parallel Data Bit4, Tune Command
6	D5	Parallel Data Bit5, Tune Command
7	D6	Tunable Filter is an internally switched 3-band. The band can be selected in Band selection bit D6, D7.
8	D7	Tunable Filter is an internally switched 3-band. The band can be selected in Band selection bit D6, D7.
9	LATCH	The filter is tuned to the frequency designated by the tune word existing on the eight control bit lines when the Strobe line is brought low. Once strobed, data existing on the tune control lines is ignored until strobed again.
10	N/C	Enable or N/C
11	N/C	Enable or N/C
12	N/C	Enable or N/C
13	Vdd	Supply Voltage Input : +5 VDC for optimum performance
14	N/C	Enable or N/C
15	N/C	Enable or N/C
16	N/C	Enable or N/C
17	GND	Digital and Analog GND
18	Vdd	Supply Voltage Input : +5 VDC for optimum performance
19	GND	Digital and Analog GND
20	Vss	High Bias Supply Voltage Input : +100 VDC for optimum performance

### 1.3 Parallel Interface Timing

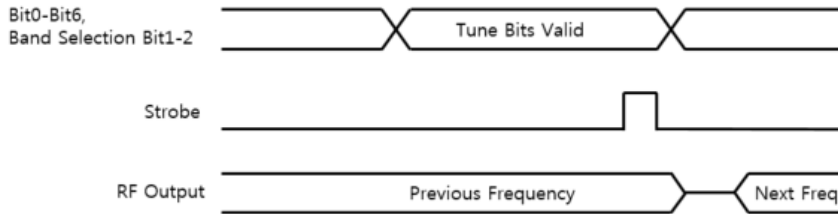

The filter is tuned to the frequency designated by the tuneword existing on the eight control bit lines when the Strobe line is brought low. Once strobed, data existing on the tune control lines is ignored until strobed again. When strobe is set, frequency changes to the next frequency.

### 1.4 Control Bit (Ex.)

CONTROL BIT	D7	D6	D5	D4	D3	D2	D1	D0	Fc(MHz)
CH	128	64	32	16	8	4	2	1	
CH1	0	0	0	0	0	0	0	0	30
CH2	0	0	0	0	0	0	0	1	30.1
CH3	0	0	0	0	0	0	1	0	30.2
CH4	0	0	0	0	0	0	1	1	30.4
.									.
.									.
.									.
CH128	0	1	1	1	1	1	1	1	88
CH129	1	0	0	0	0	0	0	0	108
.									.
.									.
.									.
CH192	1	0	1	1	1	1	1	1	225
CH193	1	1	0	0	0	0	0	0	226
.									.
.									.
.									.
CH256	1	1	1	1	1	1	1	1	512

## 2.0 Specifications

### 2.1 Electrical Specifications

Frequency Coverage:	30 – 88 MHz Band I	108-225 MHz Band II	225 – 512 MHz Band III
Input/Output Impedance:	50 $\Omega$	50 $\Omega$	50 $\Omega$
Inband Input/Output VSWR:	2.0:1 max	2.0:1 max	2.0:1 max
Insertion Loss:	3.8 dB typ. 4.0 dB max	3.2 dB typ. 3.5 dB max	4.0 dB typ. 5.0 dB max
1 dB Bandwidth:	1 MHz min	8 MHz min	8 MHz min
Selectivity:	>14 dB@ $\pm$ 10 MHz offset	-	-
% BW(3dB BW/fo)	10.0 % typ.	14.0 % typ.	9.0 % typ.
Ultimate Attenuation:	50 dB typ. @ 2 x fo	50 dB typ. @ 2 x fo	50 dB typ. @ 2 x fo
Shape Factor (30dB/3dB):	7.0 typ.	7.0 typ.	7.0 typ.

Maximum RF input Power for for linear operation	30 dBm
Out of Band RF Power Handling:	33 dBm
Inband Third Order Intercept Point:	40 dBm
Tuning Control:	Parallel (Option: Series)
Tuning Speed:	15 $\mu$ sec @ 0 dBm input
DC Power (Static)	-88 V <sub>DC</sub> @ 0.02 mA max +3.3 V <sub>DC</sub> @ 100 mA max
Operating Temperature Range:	-40 to +85 °C

## 2.2 Typical Characteristics

fo : 30 MHz

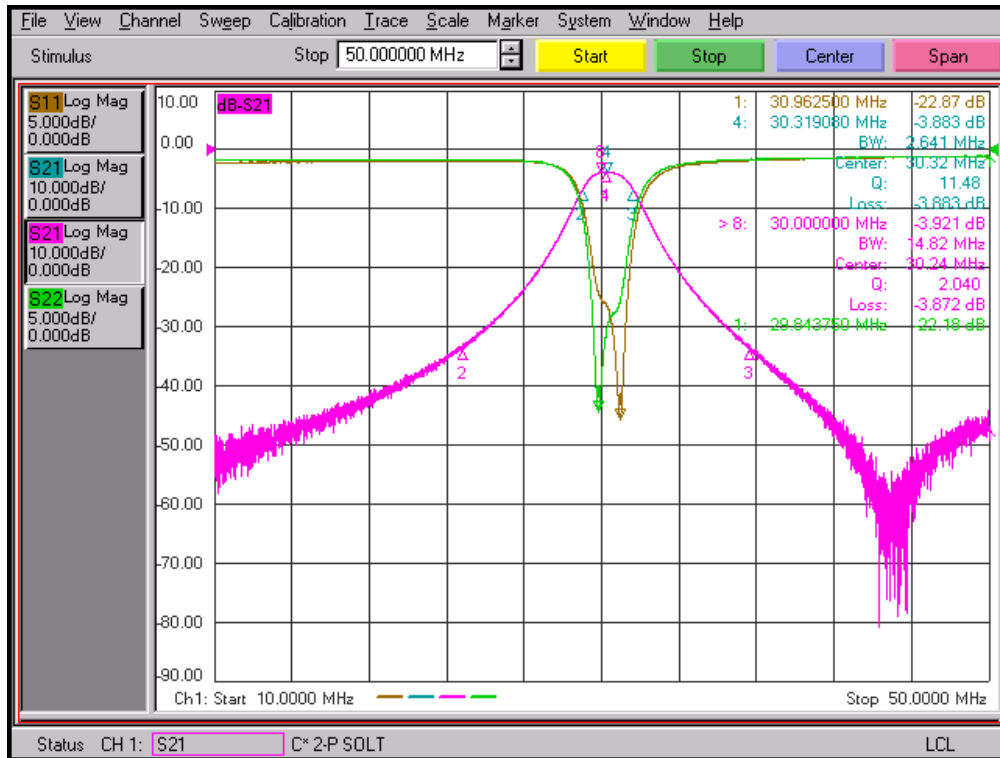

fo : 88 MHz

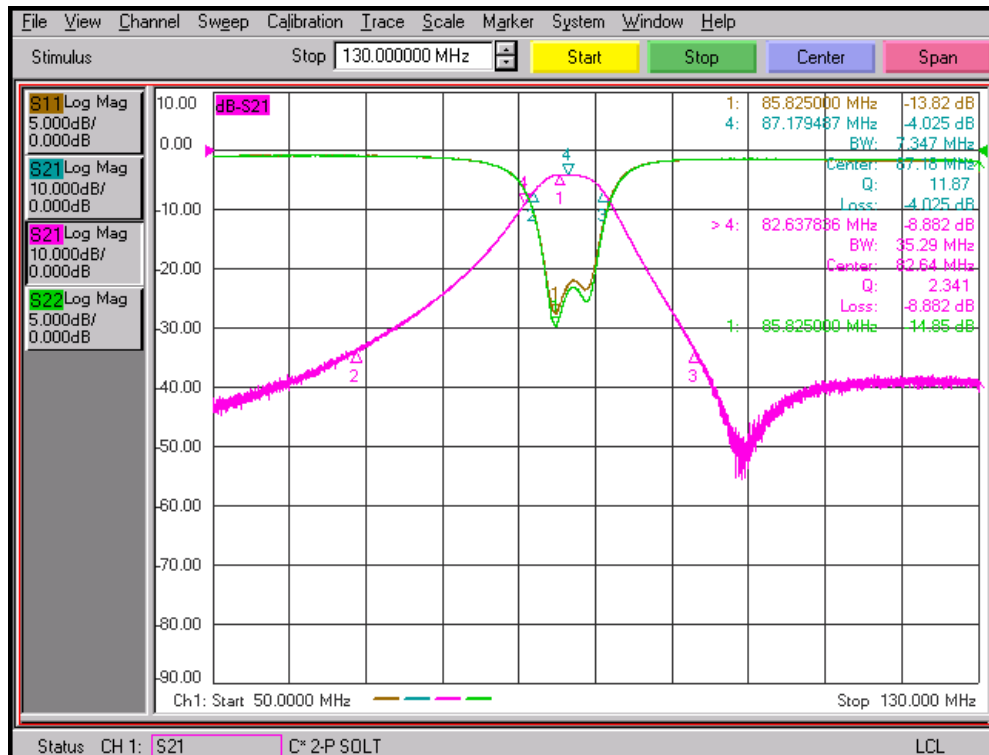

**fo : 108 MHz**

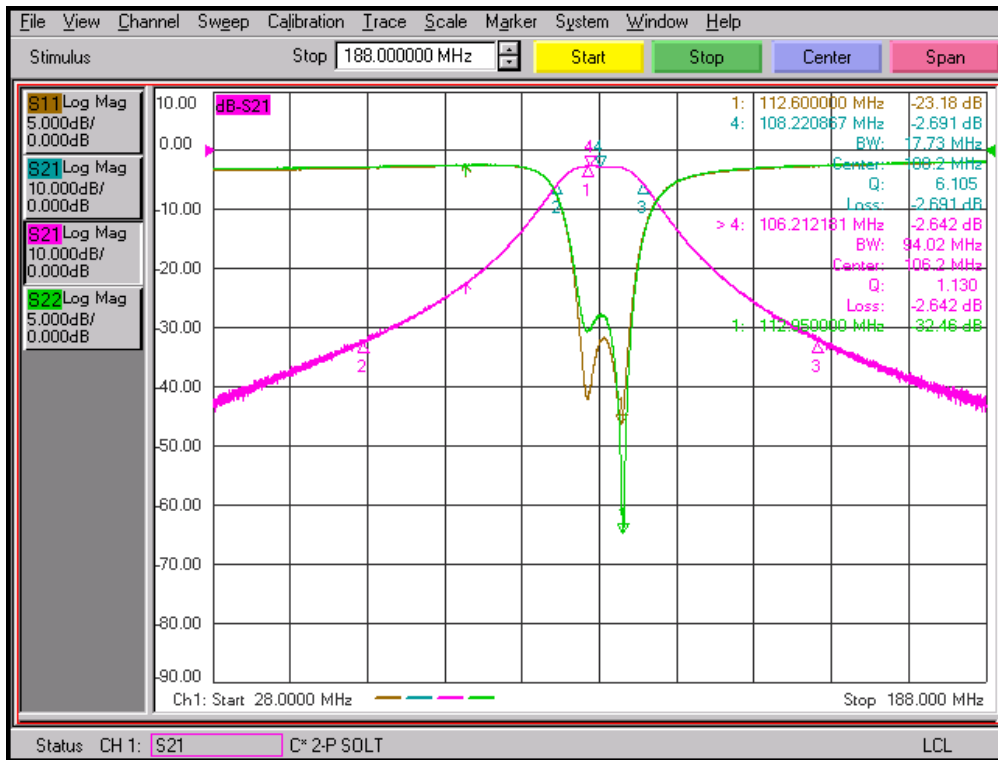

**fo : 225 MHz**

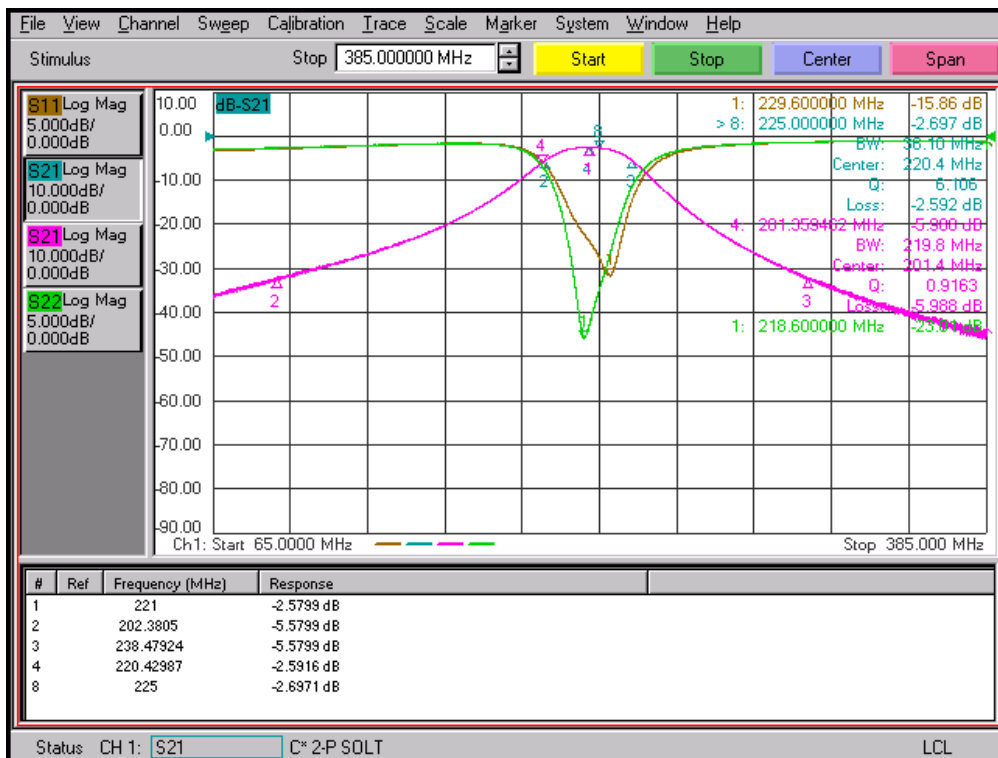

#	Ref	Frequency (MHz)	Response
1		221	-2.5799 dB
2		202.3805	-5.5799 dB
3		238.47924	-5.5799 dB
4		220.42987	-2.5916 dB
8		225	-2.6971 dB

fo : 512 MHz

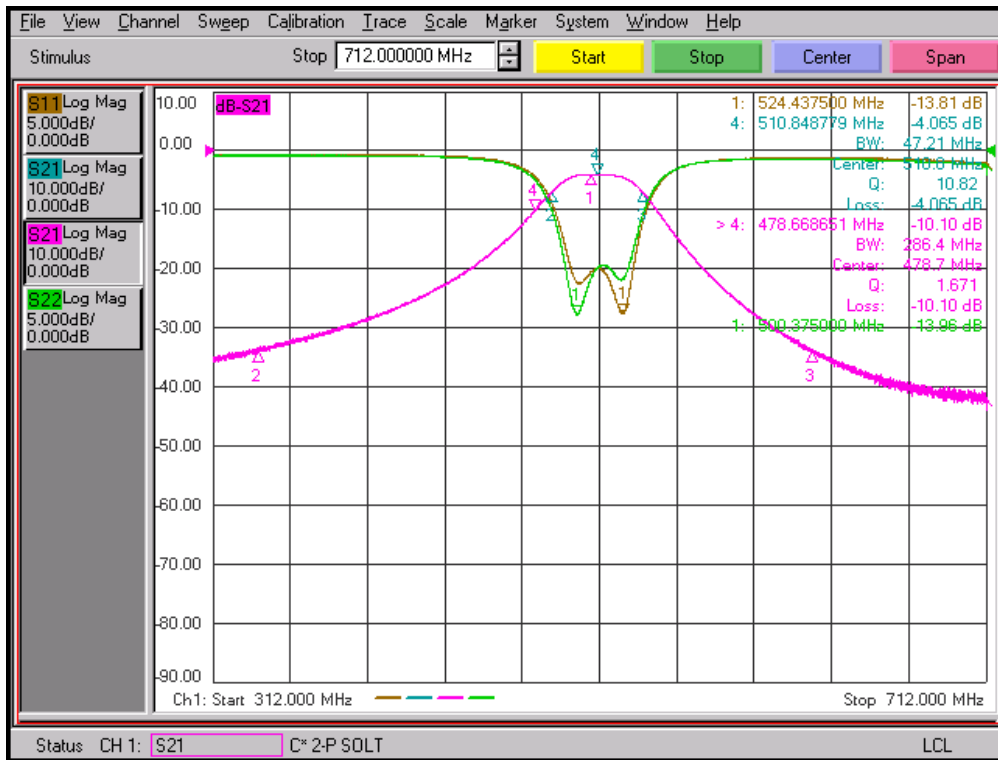



## 2.3 Mechanical Drawings

### 2.3.1. Dimension

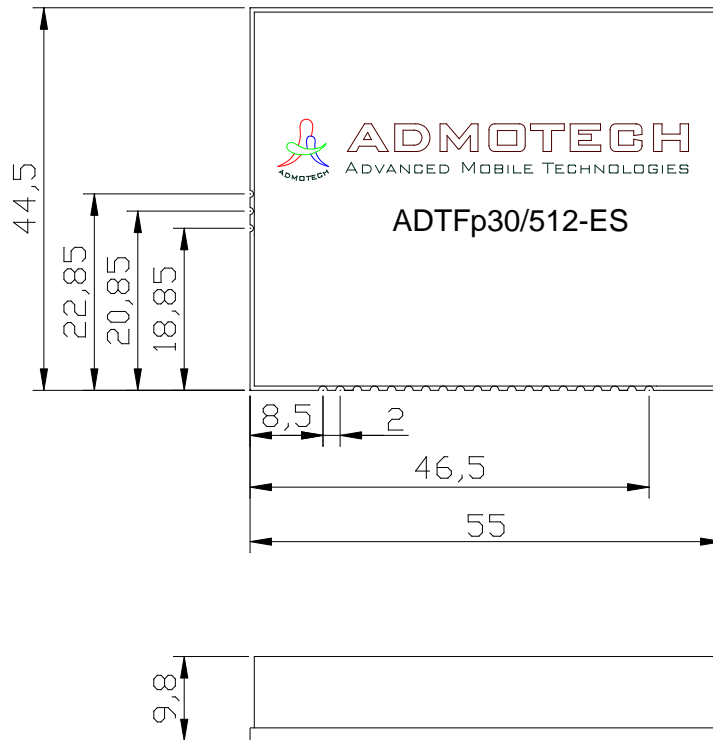

### 2.3.2. Land Pattern

Recommend Land Pattern

