



DROP-IN Isolator 4800 ~ 4900 MHz

ADI485DDT

Features

- 21dB typical Isolation, 0.35dB typical Insertion Loss at room temperature.
- Custom products available with alternate configurations such as attenuators, high power terminations, reverse circulation etc.
- Designed for Wireless Telecommunications Systems.
- RoHS Compliant

Options

The customers can choose as follows

- Direction : Clockwise(Default) or Counter Clockwise.
- T : Termination

Electrical Characteristics

Parameter	Units	Specifications
Frequency	MHz	4800 ~ 4900
Insertion Loss	dB Max.	0.5
Isolation	dB Min.	19
VSWR	Max.	1.29 : 1
Temperature	°C	- 20 ~ +85
FDW./REV. Power	W Max.	60/50
Input/Output Impedance	Ω	50

Mechanical Dimensions

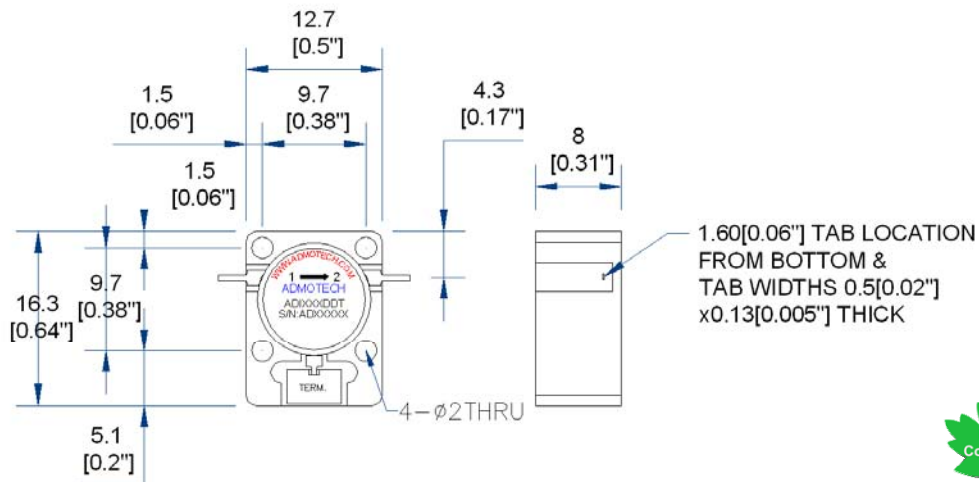

Package Size : DD

Unit: mm[inch]
Tolerance: ±0.2mm

Option Type : T

Direction:Clockwise Default