



DROP-IN Circulator

925 ~ 970 MHz

ADC094BD

Features

- 23dB typical Isolation, 0.25dB typical Insertion Loss at room temperature.
- Custom products available with alternate configurations such as attenuators, high power terminations, reverse circulation etc.
- Designed for Wireless Telecommunications Systems.
- RoHS Compliant

Options

The customers can choose as follows

- Direction : Clockwise(Default) or Counter Clockwise.

Electrical Characteristics

Parameter	Units	Specifications
Frequency	MHz	925 ~ 970
Insertion Loss	dB Max.	0.40
Isolation	dB Min.	21
VSWR	Max.	1.25 : 1
Temperature	°C	- 30 ~ +85
FDW./REV. Power	W Max.	150/100
Input/Output Impedance	Ω	50

Mechanical Dimensions

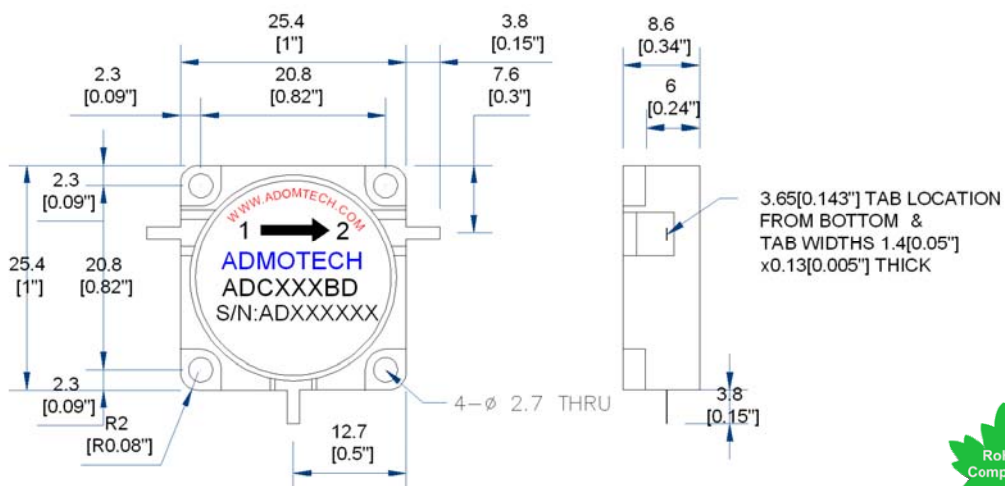

Package Size : BD
 Option Type : none
 Direction:Clockwise Default

Unit: mm[inch]
 Tolerance: ±0.2mm

If you do not find appropriate frequency range, Please contact with sales@admotech.com