



Coaxial N Type Circulator

410 ~ 430 MHz

ADC042CNWH

Features

- 20dB typical Isolation, 0.35dB typical Insertion Loss at room temperature.
- Custom products available with alternate configurations such as attenuators, high power terminations, reverse circulation etc.
- Designed for Wireless Telecommunications Systems.
- RoHS Compliant

Electrical Characteristics

Parameter	Units	Specifications
Frequency	MHz	410 ~ 430
Insertion Loss	dB Max.	0.50
Isolation	dB Min.	18
VSWR	Max.	1.33 : 1
Temperature	°C	- 20 ~ +80
FDW./REV. Power	W Max.	150/100
Input/Output Impedance	Ω	50

Mechanical Dimensions

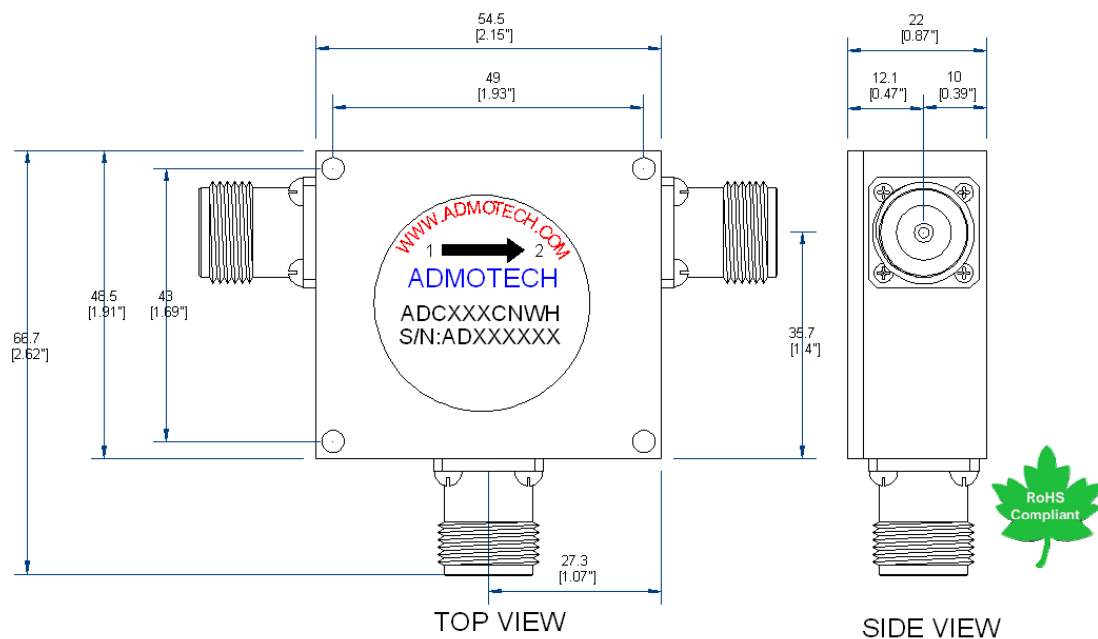
Unit: mm[inch]
Tolerance: ±0.2mm

If you do not find appropriate frequency range, Please contact with sales@admotech.com