



Coaxial N Type Circulator

350 ~ 370 MHz

ADC036CNWH

Features

- 18dB typical Isolation, 0.40dB typical Insertion Loss at room temperature.
- Custom products available with alternate configurations such as attenuators, high power terminations, reverse circulation etc.
- Designed for Wireless Telecommunications Systems.
- RoHS Compliant

Electrical Characteristics

Parameter	Units	Specifications
Frequency	MHz	350 ~ 370
Insertion Loss	dB Max.	0.55
Isolation	dB Min.	16
VSWR	Max.	1.38 : 1
Temperature	°C	- 20 ~ +80
FDW./REV. Power	W Max.	150/100
Input/Output Impedance	Ω	50

Mechanical Dimensions

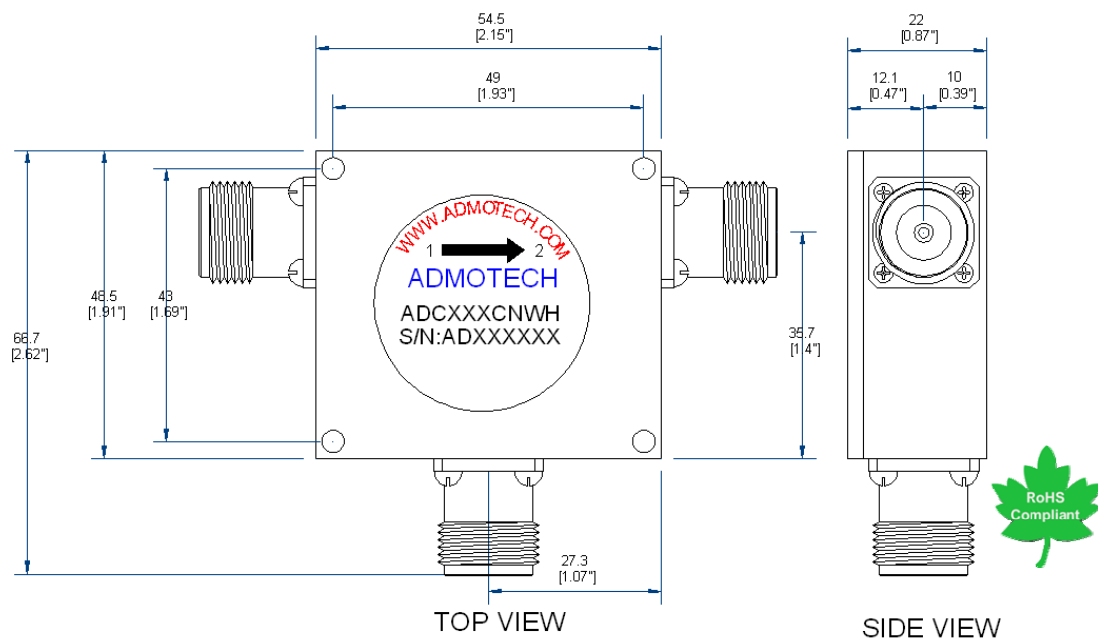

Unit: mm[inch]
Tolerance: ±0.2mm

If you do not find appropriate frequency range, Please contact with sales@admotech.com